



US AGM 2000

DATA SHEET
AGM Deep Cycle 6 -Volt



Application: Wherever Sealed, Leak Proof, Deep Cycle 6-volt batteries are needed.

Dimensions: 10.24" (260mm)L
7.09" (180mm)W
10.79" (274mm)H

Type: Sealed Non-Spillable Lead Acid (AGM)

Case material: Polypropylene / Heat Sealed

US AGM 2000 SPECIFICATIONS

BCI Group Size	Model	1-hr Rate	2-hr Rate	5-hr Rate	6-hr Rate	10-hr Rate	20-hr Rate	48-hr Rate	72-hr Rate	100-hr Rate	Voltage	Standard Terminal Type	AMP HOURS (20 HR. RATE)	MINUTES @ 75 AMPS	MINUTES @ 56 AMPS	MINUTES @ 25 AMPS	Length	Width	Height	Wet Weight Lbs (kg)
		132	150	177	183	197	210	210	227	231				120	175	460				
GC2	US AGM 2000	132	150	177	183	197	210	210	227	231	6	DUAL	210	120	175	460	(260)	(180)	(274)	60 (27.2)

CHARGING INSTRUCTIONS:

Nominal Charge Current (amps)	21
Max Charge Current (w/ temp. compensation)	42
Max Charge Voltage (temp. compensated)	7.4
Float/Maintenance Voltage (temp. compensated)	6.9
Temperature Compensation	-4 mV/cell/°C (-2 mV/cell/°F)

For automatic chargers, use settings compatible with AGM batteries

Do not charge at temperature corrected voltages above 7.5 volts (2.5 volts/cell).

Use of a voltage controlled charger is a requirement for warranty coverage.

For best cycle life, limit discharge to less than 50% of the battery's 20 hour capacity.

Deep cycle batteries need to be equalized periodically. Equalizing is an extended, low current charge performed after the normal charge cycle. This extra charge helps keep all cells in balance. Actively used batteries should be equalized once per month. Manually timed chargers should have the charge time extended approximately 3 hours. Automatically controlled chargers should be unplugged and reconnected after completing a charge.

All of our sealed AGM batteries are specifically manufactured for U.S. Battery under our guidelines assuring our customers they are being provided the highest quality AGM batteries available.

For more information or questions, please visit WWW.USBATTERY.COM

©2024 U.S. Battery Mfg., Co. All rights reserved.

US AGM 2000

DATA SHEET

AGM Deep Cycle 6 -Volt

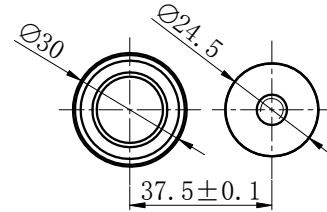
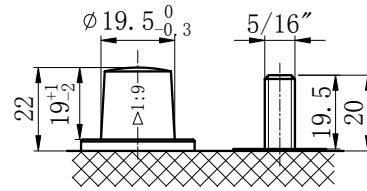
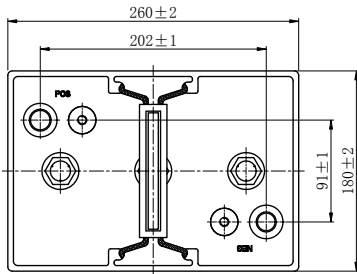
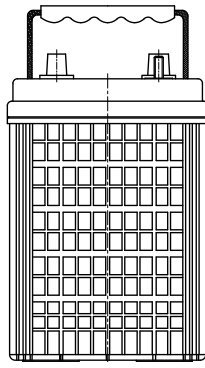
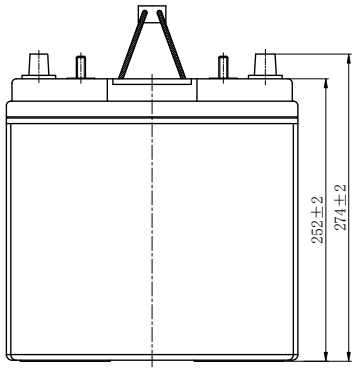

EXPECTED LIFE CYCLES VS. DOD (XC, XC2 & AGM)

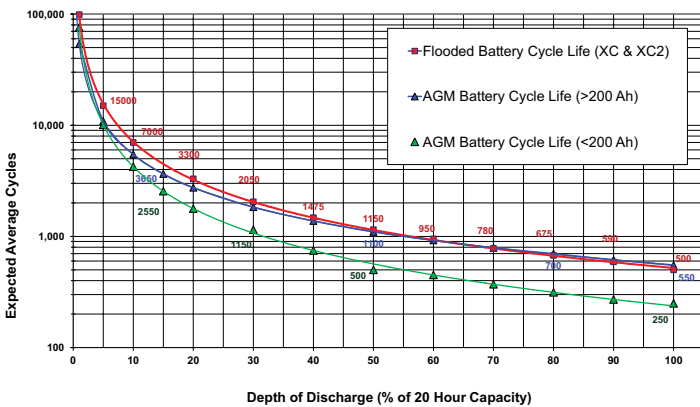

US AGM 2000 DISCHARGE TIME VS CURRENT @80° F

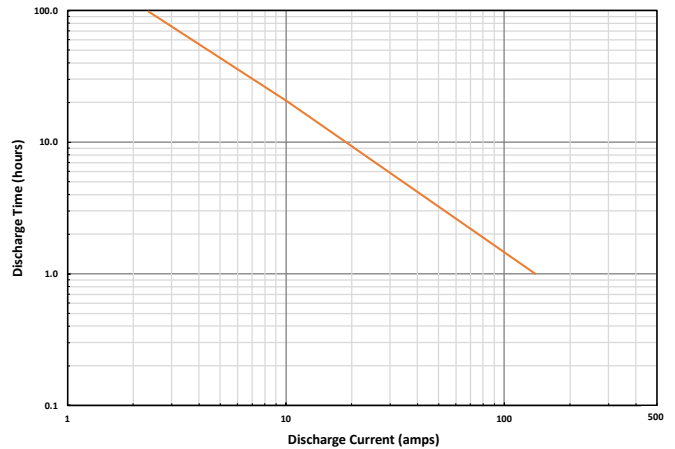

BATTERY % CAPACITY VS TEMP

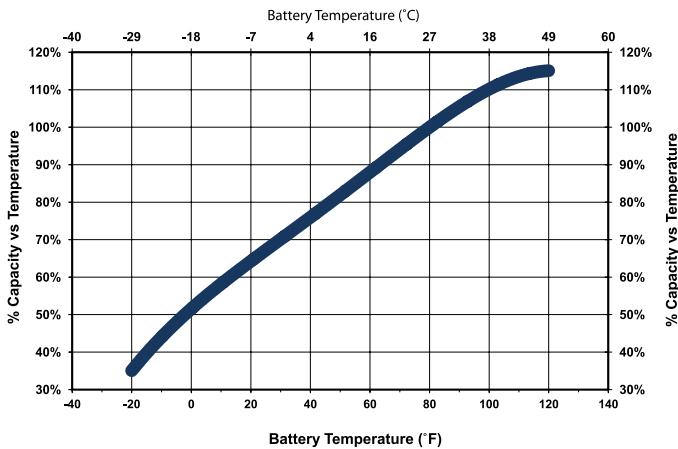

U.S. Battery Operating Temperature Guidelines

For charging, we recommend staying within 0°F to 120°F (-18 to 49°C) to avoid charging frozen batteries at low temperature or going into thermal runaway at high temperature.

For discharging, we recommend -20°F to 120°F (-29 to 49°C).

Batteries discharged at temperatures below 32°F (0°C) should be recharged immediately to avoid freezing.

Batteries discharged at temperatures above 120°F (49°C) should be allowed to cool before recharging.

Extreme temperatures can substantially affect battery performance and charging. Cold reduces battery capacity and retards charging. Heat increases water usage and can result in overcharging. Very high temperatures can cause "thermal run-away" which may lead to an explosion or fire. If extreme temperature is an unavoidable part of an application, consult a battery/charger specialist about ways to deal with the problem.

Data references within this publication are nominal and should not be considered or construed as maximum or minimum values for specifications or for final design. Data for this product type and model may vary from what is shown in this publication, and U.S. Battery Mfg. Co. makes No warranties, expressed or implied based on the data within this publication.

©2021 U.S. Battery Mfg., Co. All rights reserved. U.S. Battery is not liable for damages that may occur from any information provided in or omitted from this publication, under any circumstances. U.S. Battery Mfg., Co. reserves the right to make changes or adjustments to this publication at any time without notices or obligations.



1675 Sampson Avenue
Corona, CA 92879
(800) 695-0945

1895 Tobacco Road
Augusta, GA 30906
(800) 522-0945

717 North Belair Rd.
Evans, GA 30809
(888) 811-0945